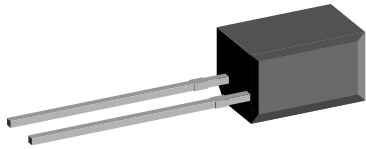


Silicon PIN Photodiode, RoHS Compliant



94 8480

FEATURES

- Package type: leaded
- Package form: side view
- Dimensions (L x W x H in mm): 5 x 4 x 6.8
- Radiant sensitive area (in mm²): 7.5
- High radiant sensitivity
- Daylight blocking filter matched with 870 nm to 950 nm emitters
- Fast response times
- Angle of half sensitivity: $\varphi = \pm 65^\circ$
- Lead (Pb)-free component in accordance with RoHS 2002/95/EC and WEEE 2002/96/EC



RoHS
COMPLIANT

DESCRIPTION

BPW82 is a PIN photodiode with high speed and high radiant sensitivity in a black, side view plastic package with daylight blocking filter. Filter bandwidth is matched with 870 nm to 950 nm IR emitters.

APPLICATIONS

- High speed detector for infrared radiation
- Infrared remote control and free air data transmission systems, e.g. in combination with TSFFxxxx series IR emitters

PRODUCT SUMMARY

COMPONENT	I_{ra} (μA)	φ (deg)	$\lambda_{0.5}$ (nm)
BPW82	45	± 65	790 to 1050

Note

Test condition see table "Basic Characteristics"

ORDERING INFORMATION

ORDERING CODE	PACKAGING	REMARKS	PACKAGE FORM
BPW82	Bulk	MOQ: 4000 pcs, 4000 pcs/bulk	Side view

Note

MOQ: minimum order quantity

ABSOLUTE MAXIMUM RATINGS

PARAMETER	TEST CONDITION	SYMBOL	VALUE	UNIT
Reverse voltage		V_R	60	V
Power dissipation	$T_{amb} \leq 25^\circ C$	P_V	215	mW
Junction temperature		T_j	100	$^\circ C$
Operating temperature range		T_{amb}	- 40 to + 100	$^\circ C$
Storage temperature range		T_{stg}	- 40 to + 100	$^\circ C$
Soldering temperature	$t \leq 5$ s	T_{sd}	260	$^\circ C$
Thermal resistance junction/ambient	Connected with Cu wire, 0.14 mm ²	R_{thJA}	350	K/W

Note

$T_{amb} = 25^\circ C$, unless otherwise specified

BASIC CHARACTERISTICS						
PARAMETER	TEST CONDITION	SYMBOL	MIN.	TYP.	MAX.	UNIT
Breakdown voltage	$I_R = 100 \mu\text{A}, E = 0$	$V_{(BR)}$	60			V
Reverse dark current	$V_R = 10 \text{ V}, E = 0$	I_{ro}		2	30	nA
Diode capacitance	$V_R = 0 \text{ V}, f = 1 \text{ MHz}, E = 0$	C_D		70		pF
	$V_R = 3 \text{ V}, f = 1 \text{ MHz}, E = 0$	C_D		25	40	pF
Open circuit voltage	$E_e = 1 \text{ mW/cm}^2, \lambda = 870 \text{ nm}$	V_o		350		mV
Short circuit current	$E_e = 1 \text{ mW/cm}^2, \lambda = 870 \text{ nm}$	I_k		38		μA
Reverse light current	$E_e = 1 \text{ mW/cm}^2, \lambda = 870 \text{ nm}, V_R = 5 \text{ V}$	I_{ra}	43	45		μA
Angle of half sensitivity		ϕ		± 65		deg
Wavelength of peak sensitivity		λ_p		950		nm
Range of spectral bandwidth		$\lambda_{0.5}$		790 to 1050		nm
Noise equivalent power	$V_R = 10 \text{ V}, \lambda = 870 \text{ nm}$	NEP		4×10^{-14}		$\text{W}/\sqrt{\text{Hz}}$
Rise time	$V_R = 10 \text{ V}, R_L = 1 \text{ k}\Omega, \lambda = 820 \text{ nm}$	t_r		100		ns
Fall time	$V_R = 10 \text{ V}, R_L = 1 \text{ k}\Omega, \lambda = 820 \text{ nm}$	t_f		100		ns

Note
 $T_{amb} = 25 \text{ }^\circ\text{C}$, unless otherwise specified

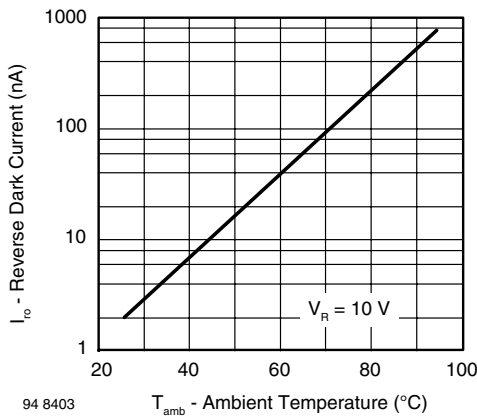
BASIC CHARACTERISTICS
 $T_{amb} = 25 \text{ }^\circ\text{C}$, unless otherwise specified


Fig. 1 - Reverse Dark Current vs. Ambient Temperature

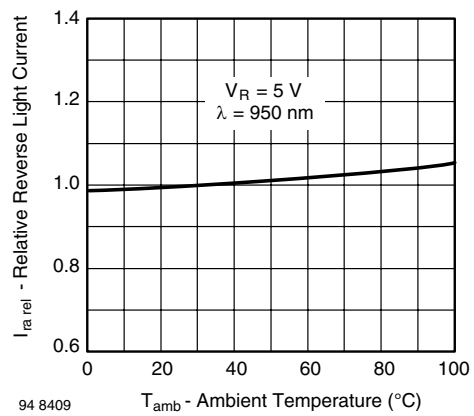


Fig. 2 - Relative Reverse Light Current vs. Ambient Temperature

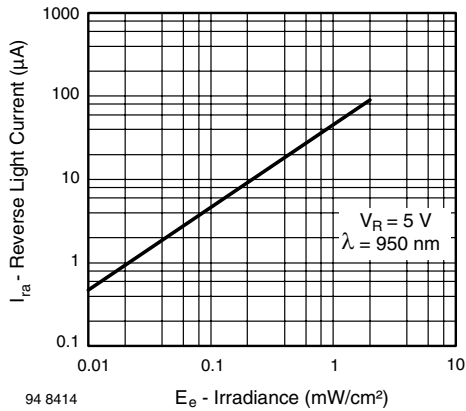


Fig. 3 - Reverse Light Current vs. Irradiance

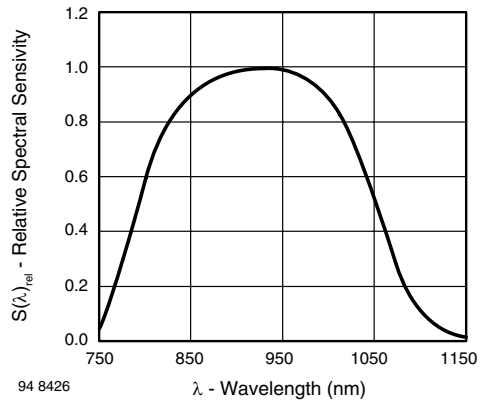


Fig. 6 - Relative Spectral Sensitivity vs. Wavelength

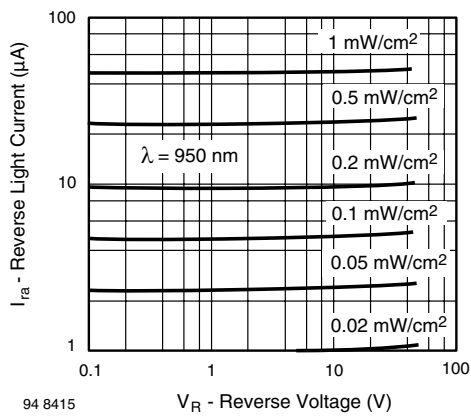


Fig. 4 - Reverse Light Current vs. Reverse Voltage

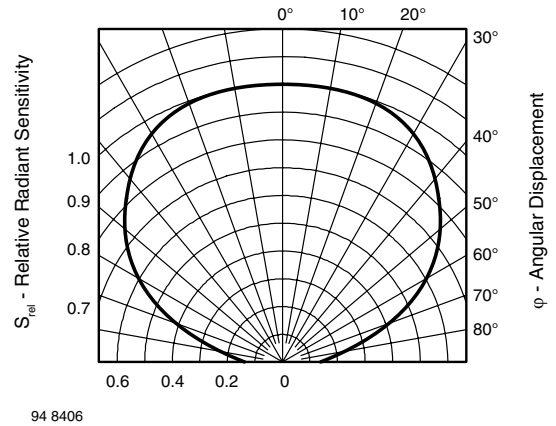


Fig. 7 - Relative Radiant Sensitivity vs. Angular Displacement

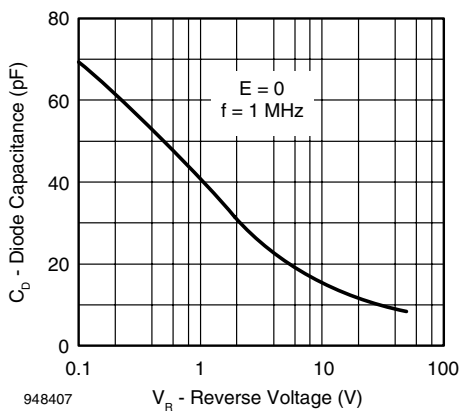
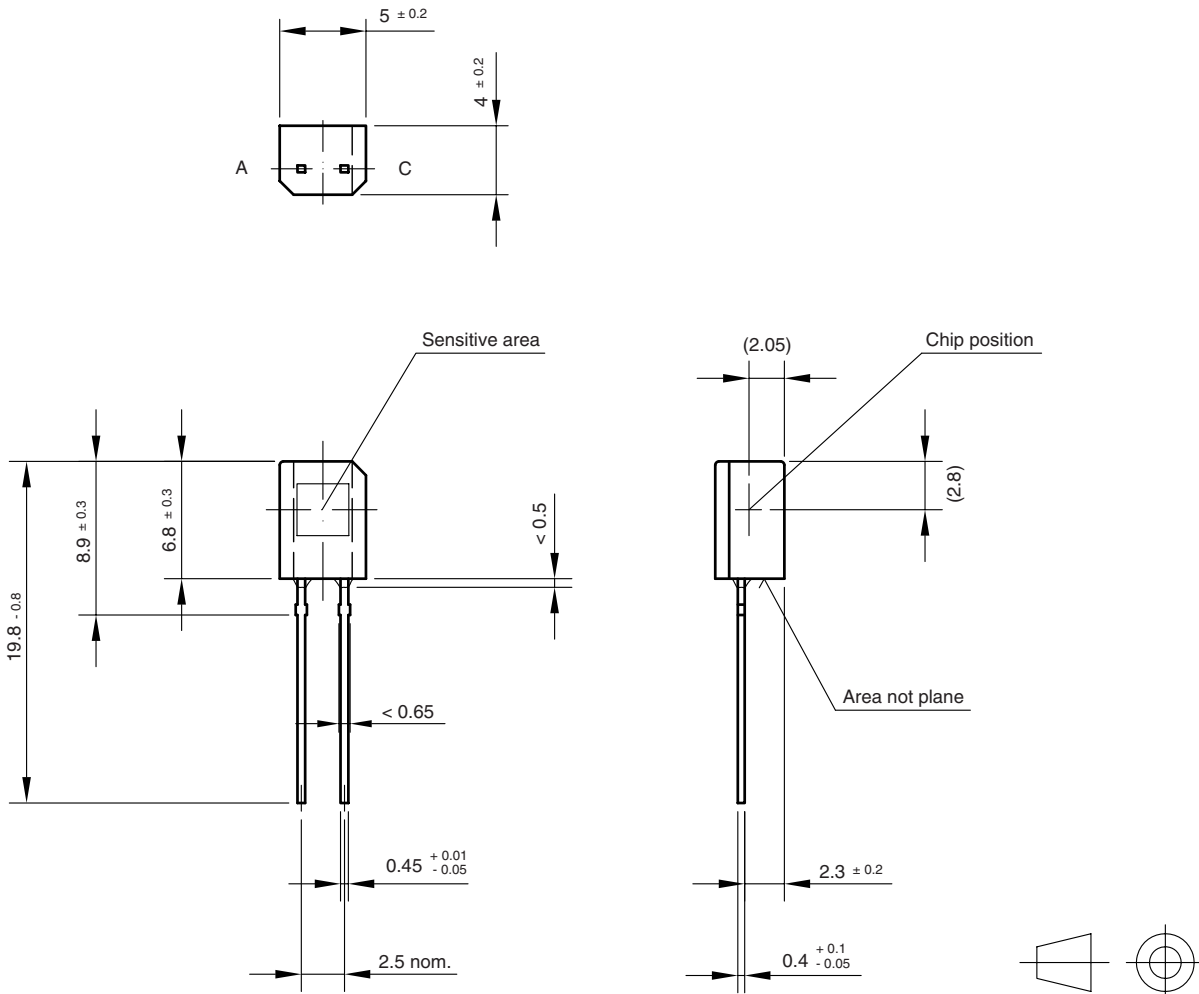


Fig. 5 - Diode Capacitance vs. Reverse Voltage



PACKAGE DIMENSIONS in millimeters



Drawing-No.: 6.544-5108.01-4

Issue:1; 01.07.96

96 12195



Disclaimer

All product specifications and data are subject to change without notice.

Vishay Intertechnology, Inc., its affiliates, agents, and employees, and all persons acting on its or their behalf (collectively, "Vishay"), disclaim any and all liability for any errors, inaccuracies or incompleteness contained herein or in any other disclosure relating to any product.

Vishay disclaims any and all liability arising out of the use or application of any product described herein or of any information provided herein to the maximum extent permitted by law. The product specifications do not expand or otherwise modify Vishay's terms and conditions of purchase, including but not limited to the warranty expressed therein, which apply to these products.

No license, express or implied, by estoppel or otherwise, to any intellectual property rights is granted by this document or by any conduct of Vishay.

The products shown herein are not designed for use in medical, life-saving, or life-sustaining applications unless otherwise expressly indicated. Customers using or selling Vishay products not expressly indicated for use in such applications do so entirely at their own risk and agree to fully indemnify Vishay for any damages arising or resulting from such use or sale. Please contact authorized Vishay personnel to obtain written terms and conditions regarding products designed for such applications.

Product names and markings noted herein may be trademarks of their respective owners.